

Active Sub Woofer

Model **PM-SUBn**

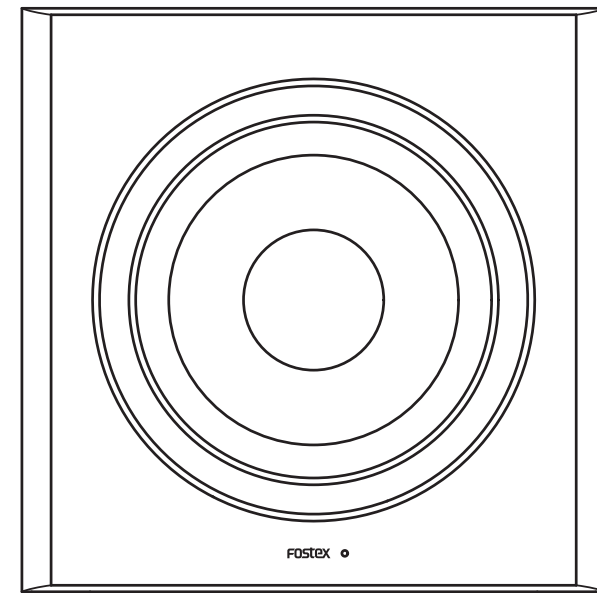

Thank you for purchasing the Fostex PM-SUBn. The PM-SUBn is an active sub woofer which widens and strengthens the shortage of low frequency region and volume level reproduced by a small speaker system. It can be used for various applications such as DTM and home theater.

Fostex

FOSTEX CO.

3-2-35 Musashino, Akishima-shi, Tokyo, Japan, 196-0021

**CAUTION**RISK OF ELECTRIC SHOCK
DO NOT OPEN

CAUTION: TO REDUCE THE RISK OF ELECTRIC SHOCK,
DO NOT REMOVE COVER (OR BACK).
NO USER - SERVICEABLE PARTS INSIDE.
REFER SERVICING TO QUALIFIED SERVICE PERSONNEL.

CAUTION:
TO PREVENT ELECTRIC SHOCK, MATCH WIDE
BLADE OF PLUG TO WIDE SLOT, FULLY INSERT.

ATTENTION:
POUR ÉVITER LES CHOCS ÉLECTRIQUES,
INTRODUIRE LA LAME LA PLUS LARGE DE LA FICHE
DANS LA BORNE CORRESPONDANTE DE LA PRISE
ET POUSSER JUSQU' AU FOND.



The lightning flash with arrowhead symbol, within an equilateral triangle, is intended to alert the user to the presence of uninsulated "dangerous voltage" within the product's enclosure that may be of sufficient magnitude to constitute a risk of electric shock to persons.



The exclamation point within an equilateral triangle is intended to alert the user to the presence of important operating and maintenance (servicing) instructions in the literature accompanying the appliance.

WARNING:

To reduce the risk of fire or electric shock, do not expose apparatus to rain or moisture.

Avertissement:

pour réduire le risque d'incendie ou de choc électrique, ne pas exposer cet appareil sous la pluie et l'humidité.

IMPORTANT SAFETY INSTRUCTIONS

1. Read these instructions.
2. Keep these instructions.
3. Heed all warnings.
4. Follow all Instructions.
5. Do not use this apparatus near water.
6. Clean only with dry cloth.
7. Do not block any ventilation openings. Install in accordance with the manufacturer's instructions.
8. Do not install near any heat sources such as radiators, heat registers, stoves, or other apparatus (including amplifiers) that produce heat.
9. Do not defeat the safety purpose of the polarized or grounding - type plug. A polarized plug has two blades with one wider than the other. A grounding type plug has two blades and a third grounding prong. The wide blade or the third prong are provided for your safety. If the provided plug does not fit into your outlet, consult an electrician for replacement of the obsolete outlet.
10. Protect the power cord from being walked on or pinched particularly at plugs, convenience receptacles, and the point where they exit from the apparatus.
11. Only use attachments/accessories specified by the manufacturer.
12. Use only with the cart, stand, tripod, bracket, or table specified by the manufacturer, or sold with the apparatus. When a cart is used, use caution when moving the cart/apparatus combination to avoid injury from tip-over.
13. Unplug this apparatus during lightning storms or when unused for long periods of time.
14. Refer all servicing to qualified service personnel. Servicing is required when the apparatus has been damaged in any way, such as power-supply cord or plug is damaged, liquid has been spilled or objects have fallen into the apparatus, the apparatus has been exposed to rain or moisture, does not operate normally, or has been dropped.
15. The apparatus shall be used in an open area.
Cet appareil doit être utilisé dans un endroit a aire ouverte.
16. Apparatus shall not be exposed to dripping or splashing and that no objects filled with liquids, such as vases, shall be placed on apparatus.
L'appareil ne doit pas éclaboussures et aucun objet ne contenant de liquide, tel qu'un vase, ne doit être placé sur l'objet.
17. Mains plug is used as disconnect device. It shall remain readily operable and should not be obstructed during intended use. To completely disconnect the apparatus from supply mains, the mains plug of the apparatus shall be disconnected from the mains socket outlet completely.
La prise du secteur et utilisé pou déconnecter le système. La prise du secteur ne doit pas être obstruée ou doit être facilement accessible pendant son utilisation. Pour être complètement déconnecté de l'alimentation d'entrée, la prise doit être débranchée du secteur.

**Declaration of EC Directive**

This equipment is compatible with the EMC Directive (2004/108/EC) - Directive on approximation of member nation's ordinance concerning the electromagnetic compatibility and with the Low Voltage Directive (73/23/EEC) - Directive on approximation of member nation's ordinance concerning electric equipment designed to be used within the specified voltage range.

The Affect of Immunity on This Equipment

The affect of the European Specification EN61000-6-1 (coexistence of electromagnetic waves - common immunity specification) on this equipment are as shown below.

In the electrical fast transient/burst requirements, surge, conducted disturbances by radio-frequency fields, power frequency magnetic field, radiate electromagnetic field requirements and static electricity discharging environment, this could be affected by generation of noise in some cases.

FOSTEX DISTRIBUTORS LIST IN EUROPE

* Including non-EU countries (as of January 2011)

<AUSTRIA>

NAME: Mega Audio GmbH
ADD: Stromberger Str. 32, D-55411 Bingen, Germany
TEL: (+49) 6721-94330, FAX: (+49) 6721-32046

<BELGIUM>

NAME: General Audio
ADD: Raymond Pelgrimsaan 101, B-1702 Groot-Bijgaarden, Belgium
TEL: (+32) 2-4630650, FAX: (+32) 2-4661500

<BULGARIA>

NAME: Shark Art
ADD: 15 Hristo Popovich Str., Varna 9000, Bulgaria
TEL: (+359) 52-600172, FAX: (+359) 52-250578

<CZECHO>

NAME: Praha Music Center spol s.r.o.
ADD: Ocelarska 937/39, Praha 9, 190 00, Czecho
TEL: (+420) 226-011-111, FAX: (+420) 226-011-112

<DENMARK>

NAME: Benum Nordic A/S
ADD: Meterbuen 18, Skovlunde, 2740 Denmark
TEL: (+45) 4451-8900, FAX: (+45) 4451-8911

<FINLAND>

NAME: Norettron Oy Audio
ADD: P. O. Box 22, FIN-02631 Espoo, Finland
TEL: (+358) 9-5259330, FAX: (+358) 9-52593352

<FRANCE>

NAME: Sennheiser France
ADD: 128 bis, avenue Jean-Jaures, 94851 Ivry-sur-Seine Cedex, France
TEL: (+33) 1 4987 0300, FAX: (+33) 1 4987 0324

<GERMANY>

NAME: Mega Audio GmbH
ADD: Stromberger Str. 32, D-55411 Bingen, Germany
TEL: (+49) 6721-94330, FAX: (+49) 6721-32046

<GREECE>

NAME: Bon Studio S. A.
ADD: 6 Zaimi Street, Exarchia, 106.83 Athens, Greece
TEL: (+30) 210-3809-605, 606, 607, 608
FAX: (+30) 210-3845-755, 210-3827-868

<HUNGARY>

NAME: ATEC Hungary Kft
ADD: H-110/ Budapest, Fogado u. 3, Hungary
TEL: (+36) 1-4319005, FAX: (+36) 1-4319006

<ICELAND>

NAME: I. D. elrf. electronic Ltd.
ADD: ARMULA 38 108 REYKJAVIK, ICELAND
TEL: (+354) 588 5010, FAX: (+354) 588 5011

<ITALY>

NAME: Proel S. p. A.
ADD: Zona Via Alla Ruenia, 37/43 64027 - Sant'Omero (Teramo), Italy
TEL: (+39) 0861-81241, FAX: (+39) 0861-887862

<THE NETHERLANDS>

NAME: IEMKE ROOS AUDIO B. V.
ADD: Kuiperbergweg 20, 1101 AG Amsterdam, The Netherlands
TEL: (+31) 20-697-2121, FAX: (+31) 20-697-4201

<NORWAY>

NAME: Siv. Ing. Benum AS
ADD: P. O. Box 145, Vinderen, 0319 Oslo, Norway
TEL: (+47) 2213 9900, FAX: (+47) 2214 8259

<POLAND>

NAME: Mega Music Spolka z o.o
ADD: Ul. Lesna 15, 81-876 Sopot, Poland
TEL: (+48) 58-551-18-82, FAX: (+48) 58-551-18-72

<SPAIN>

NAME: Letusa S. A.
ADD: C/Laguna 10, 28923 Alcorcon, Madrid, Spain
TEL: (+34) 91-4862800, 91-4470898, FAX: (+34) 91-6414597

<SWEDEN>

NAME: Benum Nordic A/S
ADD: Aldermansvagen 17, 171 48 Solna, Sweden
TEL: (+46) 8 207710

<SWITZERLAND>

NAME: Audio Bauer Pro AG
ADD: Bernerstrasse-Nord 182, CH-8064 Zurich, Switzerland
TEL: (+41) 1-4323230, FAX: (+41) 1-4326558

<UK>

NAME: SCV London
ADD: 40 Chigwell Lane, Oakwood Hill Industrial Estate, Loughton, Essex IG10 3NY U. K.
TEL: (+44) 20-8418-0778, FAX: (+44) 20-8418-0624

Characteristics Chart

Output sound pressure level measured in the anechoic room

The LOW-PASS FREQ. control knob adjusts the frequency curve as shown in the graph below. The characteristics are measured with PM-SUBn in sole use.

PM-SUBn Output sound pressure level characteristics

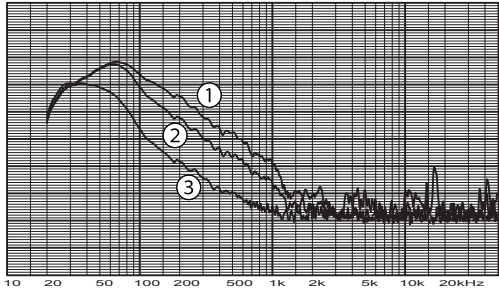

PM-SUBn setting

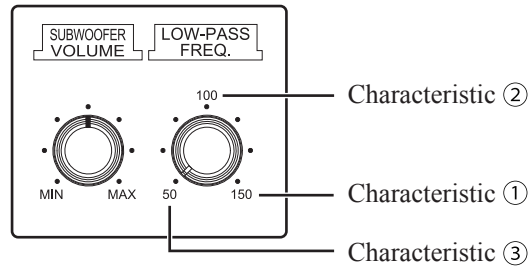

The graphs below show the characteristics when PM-SUBn is connected to PM0.4n and PM0.5n. Setting the PM-SUBn SUBWOOFER VOLUME and LOW-PASS FREQ. at the position below achieves the best sound performance indicated by the thick line in the graph. The output sound pressure varies depending on room acoustic characteristics and the PM-SUBn/main speaker system installation position. Referring to the setting example, set the best volume position so that the low frequency output from both PM-SUBn and the main speaker system is coordinated.

PM0.4n + PM-SUBn characteristics

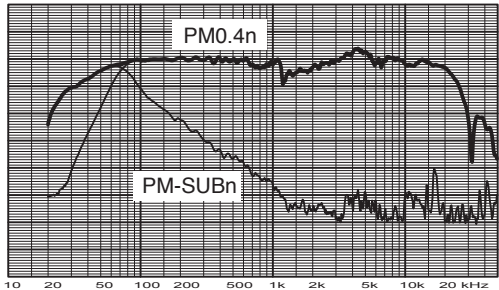

PM0.4n volume setting: Max

PM-SUBn setting

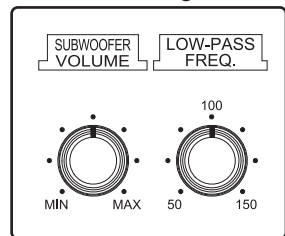

PM0.5n + PM-SUBn characteristics

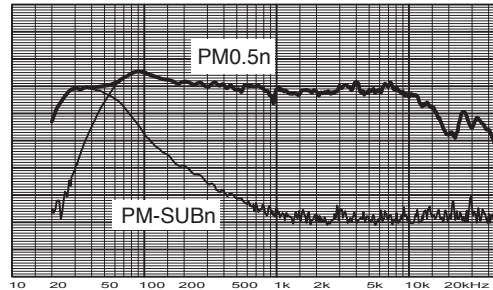

PM0.5n volume setting: Half

PM-SUBn setting

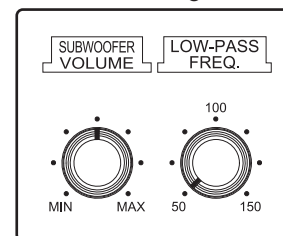

About switching PHASE

The sound pressure level varies between the 0° and 180° PHASE SW position. In a normal environment, setting the PHASE SW at 0° rather achieves a flat characteristic. However, depending on an installation position and a distance between PM-SUBn and the main speaker system, there is a case that setting the PHASE SW at 180° realizes a smoother reproduction from low to high frequency region.

PM0.4n + PM-SUBn phase characteristics

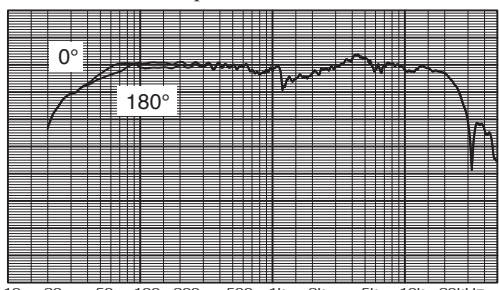

PM0.5n + PM-SUBn phase characteristics

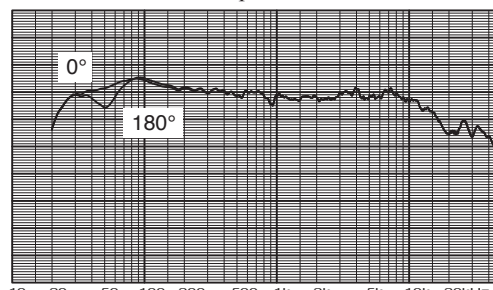

Main Features

Active sub woofer with a closed cabinet optimized for PM0.4n
The enclosure volume is downsized by 25% comparing to PM0.5SUB (MK2). This allows PM-SUBn to install more flexibly. With the closed cabinet, you do not have to pay attention to the bass-reflex enclosure duct direction.

A long-stroke 20-cm speaker unit exclusively designed as a sub woofer
A light BKP (Bleached Kraft Pulp) and strong Kevlar fiber mixed material is used for the cone paper of the speaker. Also a highly durable, light and high internal-loss SBR system foamed rubber is used for the speaker surrounding.

A closed wooden cabinet with a shining front baffle painted in glossy-black and optimized stiffness establishes a high-quality sound reproduction.

Driving a sub woofer with 68W high-power amplifier
The RCA pin and phone are employed for the INPUT/THRU OUT jacks. The stereo RCA pin cable (1.5 m), stereo mini - RCA pin cable (1.5 m) and 2 x phone - phone cables (2 m) are provided as standard accessories. Without purchasing extra cables, you can connect PM0.4n/PM0.5n and PC with PM-SUBn. The volume, cross-over frequency (50 ~ 150 Hz) and the phase (0° or 180°) can be adjusted for your usage environment.

PM-SUBn can be used for various applications such as DTM and home theater.

Specifications

•Type	: Sub woofer with built-in power amplifier
•Amplifier Section	
•Rated Output	: 68 W
•Input Sensitivity	: 100 mV
•Input Impedance	: 20 kΩ or more (No signal is connected to THRU OUT.)
•Output Terminal (THRU OUT)	: ø6 mm TS phone jack, RCA pin jack
•Functions	: Phase switch (0°/180°), cross-over frequency adjustment (50 ~ 150 Hz), volume
•Speaker Section	
•Type	: Closed type acoustic suspension
•Speaker Unit	: 20 cm cone type (simplified magnetic shield)
•Impedance	: 8 Ω
•Power	: AC120 V / 60 Hz, AC230 V / 50/60 Hz, 60 W
•Dimensions	: 300 (W) x 301.2 (H) x 364 (D) mm
•Weight	: About 11.6 kg
•Standard Accessories	: Stereo RCA pin cable (1.5 m), stereo mini - RCA pin cable (1.5 m), white phone - phone cables (2 m), red phone - phone cables (2 m)

Product improvement may warrant a change of specifications, newer materials or cosmetics. Changes in specifications and features may be made without notice or obligations.

Dimensions

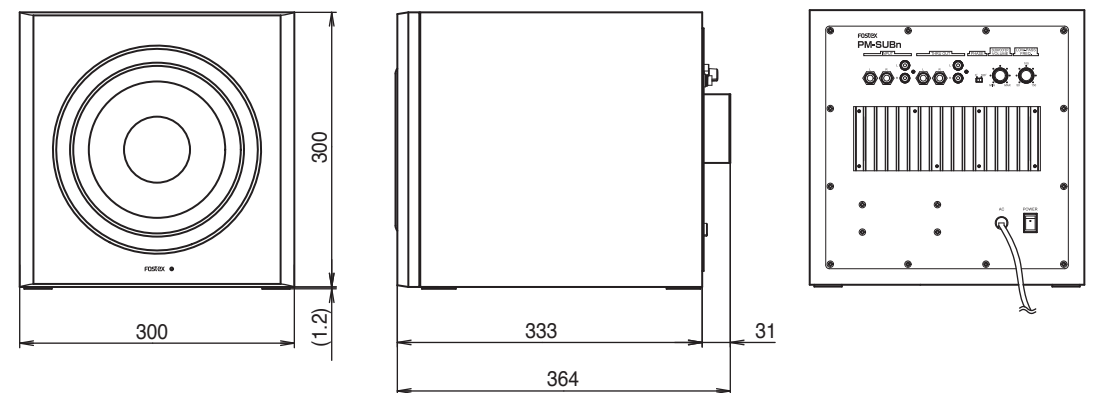

Names & Functions

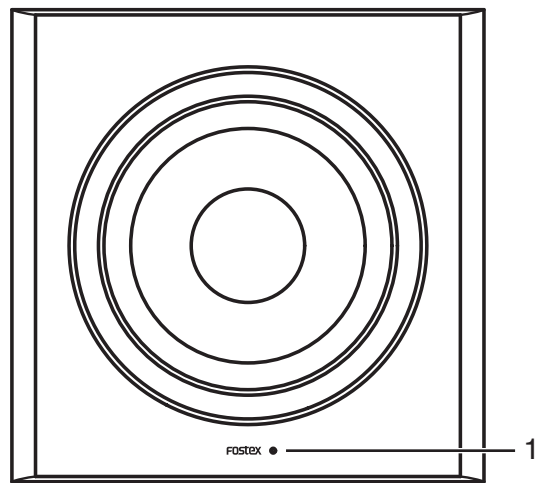

1. Power indicator

It indicates the built-in power amplifier power on/off condition. It is lit when turning on the [POWER] switch. It is unlit when turning off the [POWER] switch.

2. [INPUT] terminals

A signal source output from PC/portable music player or a line level signal output from an amplifier is connected to the [INPUT] terminals. If the signal source is connected to the PHONE jack, the signal source fed to the RCA terminal is cut.

3. [THRU OUT] terminal

A signal fed to the [INPUT] terminal is output from the [THRU OUT] terminal regardless of the power switch on/off condition. If the signal is taken out from the PHONE terminal, the signal source output from the RCA terminal is cut.

4. [PHASE 0°, 180°] switch

This switch changes the sub woofer phase between 0° and 180°.

5. [SUB WOOFER VOLUME] adjusting knob

It adjusts the output level of PM-SUBn.

6. [LOW-PASS FREQ.] adjusting knob

It adjusts the cross-over frequency of the low-pass filter from 50 to 150 Hz.

7. Heat sink

<CAUTION>

When this unit is used for a long time, the heat sink heats up. Do not touch it with a bare hand. You might suffer a burn. Please place the unit in order not to bother the heat sink radiation.

8. [POWER] switch

Power off and on the built-in power amplifier. When powering off/on, fully turn down both the PM-SUBn [SUB WOOFER VOLUME] and the connected powered speaker output volume.

9. AC cable

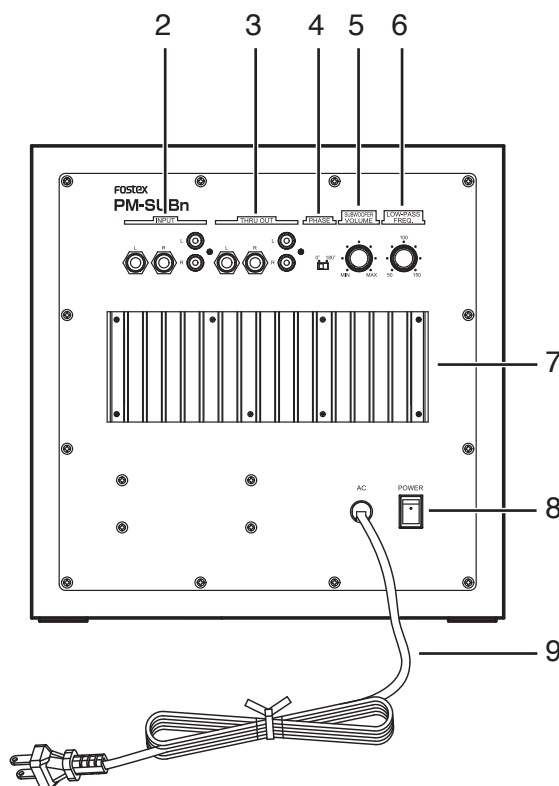

Caution When Cleaning

Cleaning the front baffle/enclosure with caution.

- If there are marks attached on the enclosure surface, squeeze a soft cloth steeped into a watered-down neutral detergent and wipe the surface with the cloth.
- If dust is attached on the speaker unit surface, sweep it lightly using a duster. Do not touch the unit surface directly with your hand or clean it with a wet wiping cloth.

Connection Method

■ Connecting PM-SUBn to PM0.4n (x 2 units)

Connect a stereo signal source from PC/portable music player to the PM-SUBn INPUT terminals (L, R). Next, connect the PM-SUBn THRU terminal (L, R) to a pair of PM0.4n INPUT terminals. The connection is the same when PM0.5n is used as a main speaker system.

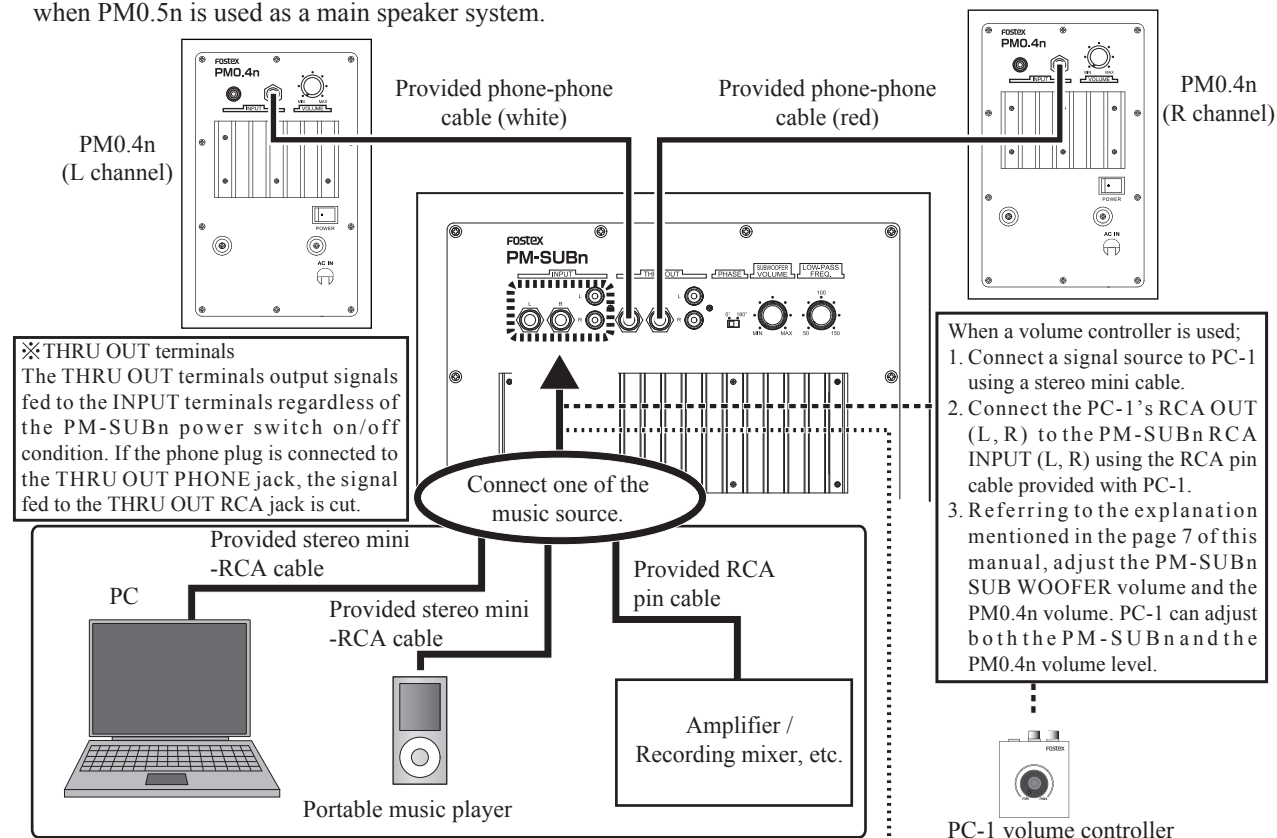

■ Connecting PM-SUBn (x 2 units) to PM0.4n (x 2 units)

Using 2 units of PM-SUBn improves the low sound massiveness. Also L and R independent signals allow more realistic sound reproduction.

PM0.4n placed on the L side

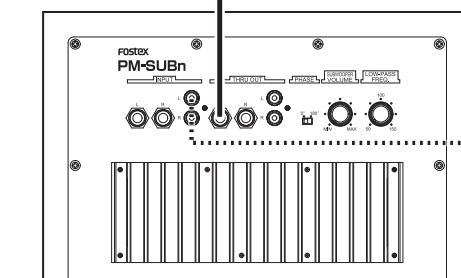
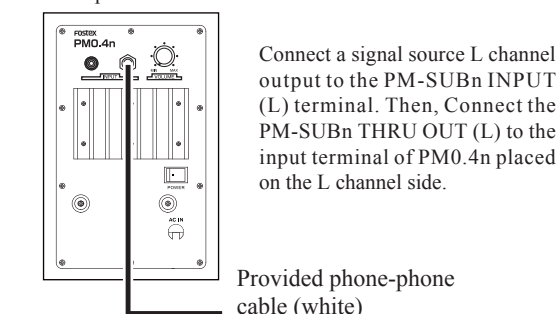

PM0.4n placed on the R side

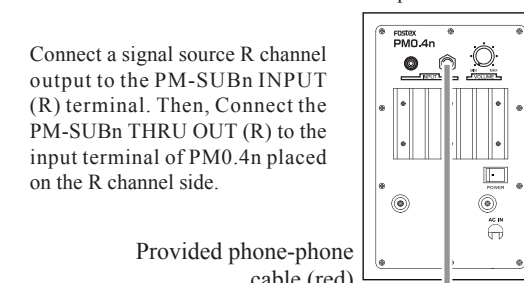

Make sure to power off the amplifier and then connect the cables.